

University of Nebraska - Lincoln

DigitalCommons@University of Nebraska - Lincoln

The Handbook: Prevention and Control of Wildlife
Damage

Wildlife Damage Management, Internet Center for

1-1-1994

EUROPEAN STARLINGS

Ron J. Johnson

Extension Wildlife Specialist, Department of Forestry, Fisheries and Wildlife, University of Nebraska, Lincoln 68583

James F. Glahn

Research Wildlife Biologist, Denver Wildlife Research Center, USDA-APHIS-ADC, Mississippi Research Station, Mississippi State, Mississippi 39762-6099

Johnson, Ron J. and Glahn, James F., "EUROPEAN STARLINGS" (1994). *The Handbook: Prevention and Control of Wildlife Damage*. Paper 72.

<http://digitalcommons.unl.edu/icwdmhandbook/72>

This Article is brought to you for free and open access by the Wildlife Damage Management, Internet Center for at DigitalCommons@University of Nebraska - Lincoln. It has been accepted for inclusion in The Handbook: Prevention and Control of Wildlife Damage by an authorized administrator of DigitalCommons@University of Nebraska - Lincoln.

Ron J. Johnson
Extension Wildlife Specialist
Department of Forestry, Fisheries
and Wildlife
University of Nebraska
Lincoln, Nebraska 68583-0819

James F. Glahn
Research Wildlife Biologist
Denver Wildlife Research Center
USDA-APHIS-ADC
Mississippi Research Station
Mississippi State, Mississippi 39762-6099

EUROPEAN STARLINGS

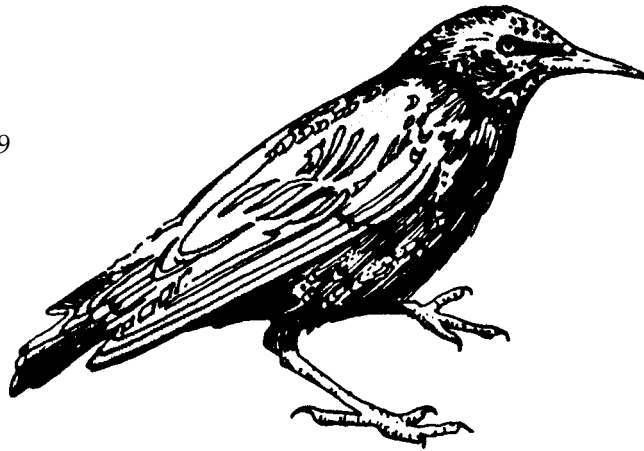
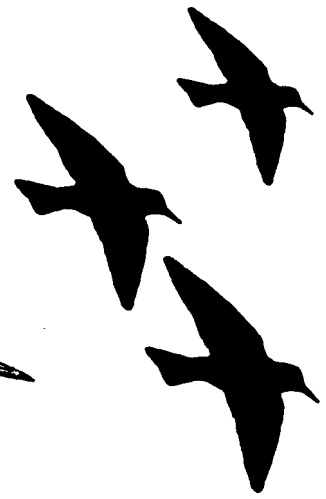

Fig. 1. European starling, *Sturnus vulgaris*

Damage Prevention and Control Methods

Exclusion

Close all openings larger than 1 inch (2.5 cm).

Place covering at 45° angle on ledges.

Porcupine wires on ledges or rafters.

Netting to prevent roosting on building beams or to protect fruit crops.

PVC or rubber strips to cover door openings; netting where frequent access is not needed.

Cultural Methods and Habitat Modification

Reduce availability of food and water at livestock facilities: remove spilled grain and standing water; use bird-proof feeders and storage facilities; feed livestock in open sheds; where appropriate, feed in late afternoon or at night; lower water level in waterers.

Modify roost sites by closing buildings; exclude from roost areas with netting (for example, under roof beams); modify specific perch sites.

For tree roosts, prune branches of specific trees or thin trees from groves.

Frightening

Frightening devices include recorded distress or alarm calls, various sound-producing devices, chemical frightening agents (Avitrol®), lights, and bright objects. Use with fruit crops and starling roosts. Also useful at livestock facilities in warm climates and at facilities located near major roosts.

Repellents

Soft sticky materials (polybutenes) discourage roosting on ledges.

Starling repellent is currently under development: methyl anthranilate (grape flavoring). If successful, it may be useful for protecting fruit and as a livestock feed additive.

Toxicants

Starlicide: toxic bait for use around livestock facilities and, in some situations, at roost sites.

Toxic perches: can be useful for certain industrial and other structural roost situations.

Fumigants

None are registered.

Trapping

Nest-box traps, for use during nesting season.

Decoy traps may be useful around orchards or livestock facilities. Proper care for trap and decoy birds is necessary.

Shooting

Helpful as a dispersal or frightening technique. Not effective in reducing overall starling numbers.



PREVENTION AND CONTROL OF WILDLIFE DAMAGE — 1994

Cooperative Extension Division
Institute of Agriculture and Natural Resources
University of Nebraska - Lincoln

United States Department of Agriculture
Animal and Plant Health Inspection Service
Animal Damage Control

Great Plains Agricultural Council
Wildlife Committee

Identification

Starlings are robin-sized birds weighing about 3.2 ounces (90 g). Adults are dark with light speckles on the feathers. The speckles may not show at a distance (Fig. 1). The bill of both sexes is yellow during the reproductive cycle (January to June) and dark at other times. Juveniles are pale brown to gray.

Starlings generally are chunky and hump-backed in appearance, with a shape similar to that of a meadowlark. The tail is short, and the wings have a triangular shape when outstretched in flight. Starling flight is direct and swift, not rising and falling like the flight of many blackbirds.

Range

Since their introduction into New York in the 1890s, starlings have spread across the continental United States, northward to Alaska and the southern half of Canada, and southward into northern Mexico. They are native to Eurasia, but have also been introduced in South Africa, Australia, New Zealand, and elsewhere.

Habitat

Starlings are found in a wide variety of habitats including cities, towns, farms, ranches, open woodlands, fields, and lawns. Ideal nesting habitat would include areas with trees or other structures that have cavities suitable for nesting and short grass (turf) areas or grazed pastures for foraging. Ideal winter habitat would include areas with structures and/or tall trees for daytime loafing (resting) and nighttime roosting; and grazed pastures, open water areas, and livestock facilities for foraging.

Food Habits

Starlings consume a variety of foods, including fruits and seeds of both wild and cultivated varieties. Insects, especially Coleoptera and Lepidoptera lawn grubs, and other invertebrates total about one-half of the diet overall,

and are especially important during the spring breeding season. Other items including livestock rations and food in garbage become an important food base for wintering starlings.

General Biology, Reproduction, and Behavior

European starlings were brought into the United States from Europe. They were released in New York City in 1890 and 1891 by an individual who wanted to introduce to the United States all of the birds mentioned in Shakespeare's works. Since that time, they have increased in numbers and spread across the country. They were first observed in Nebraska in 1930, in Colorado in 1939, and in California in 1942. The starling population in the United States is estimated at 140 million birds.

Starlings nest in holes or cavities almost anywhere, including tree cavities, birdhouses, and holes in buildings or cliff faces. Females lay 4 to 7 eggs which hatch after 11 to 13 days of incubation. Young leave the nest when they are about 21 days old. Both parents help build the nest, incubate the eggs, and feed the young. Sometimes 2 clutches of eggs are laid per season, but most of the production is from the first brood fledged.

Although starlings are not always migratory, some will migrate up to several hundred miles, while others may remain in the same general area throughout the year. Hatching-year starlings are more likely to migrate than adults, and they tend to migrate farther.

Outside the breeding season, starlings feed and roost together in flocks. Starling and blackbird flocks often roost together in urban landscape trees or in small dense woodlots or overcrowded tree groves. They choose trees or groves that offer ample perches so that all may roost together. In colder weather they choose dense vegetation such as coniferous trees or structures (such as barns, urban structures) that provide protection from wind and

cold. Fall-roosting flocks are relatively small (from several hundred to several thousand birds), but because they are spread over large geographic areas, they can cause widespread nuisance problems. In contrast, winter-roosting flocks are large (sometimes exceeding 1 million birds), but are often confined to a few acres (ha). Some of the winter roosting areas are occupied by starlings year after year (Fig. 2). Each day they may fly 15 to 30 or more miles (24 to 48 km) from roosting to feeding sites. During the day when not feeding, they may perch in smaller groups inside farm buildings or in other warm, protected spots in and around urban structures.

Damage and Damage Identification

Starlings are frequently considered pests because of the problems they cause, especially at livestock facilities (Fig. 3) and near urban roosts. Starlings may selectively eat the high-protein supplements that are often added to livestock rations.

Starlings may also be responsible for transferring disease from one livestock facility to another. This is of particular concern to swine producers. Tests have shown that the transmissible gastroenteritis virus (TGE) can pass through the digestive tract of a starling and be infectious in the starling feces. Researchers, however, have also found healthy swine in lots with infected starlings. This indicates that even infected starlings may not always transmit the disease, especially if starling interaction with pigs is minimized. TGE may also be transmitted on boots or vehicles, by stray animals, or by infected swine added to the herd. Although starlings may be involved in the spread of other livestock diseases, their role in transmission of these diseases is not yet understood.

Starlings cause other damage by consuming cultivated fruits such as grapes, peaches, blueberries, strawberries, figs, apples, and cherries. They were recently found to damage ripening (milk stage) corn, a problem primarily associated with blackbirds. In

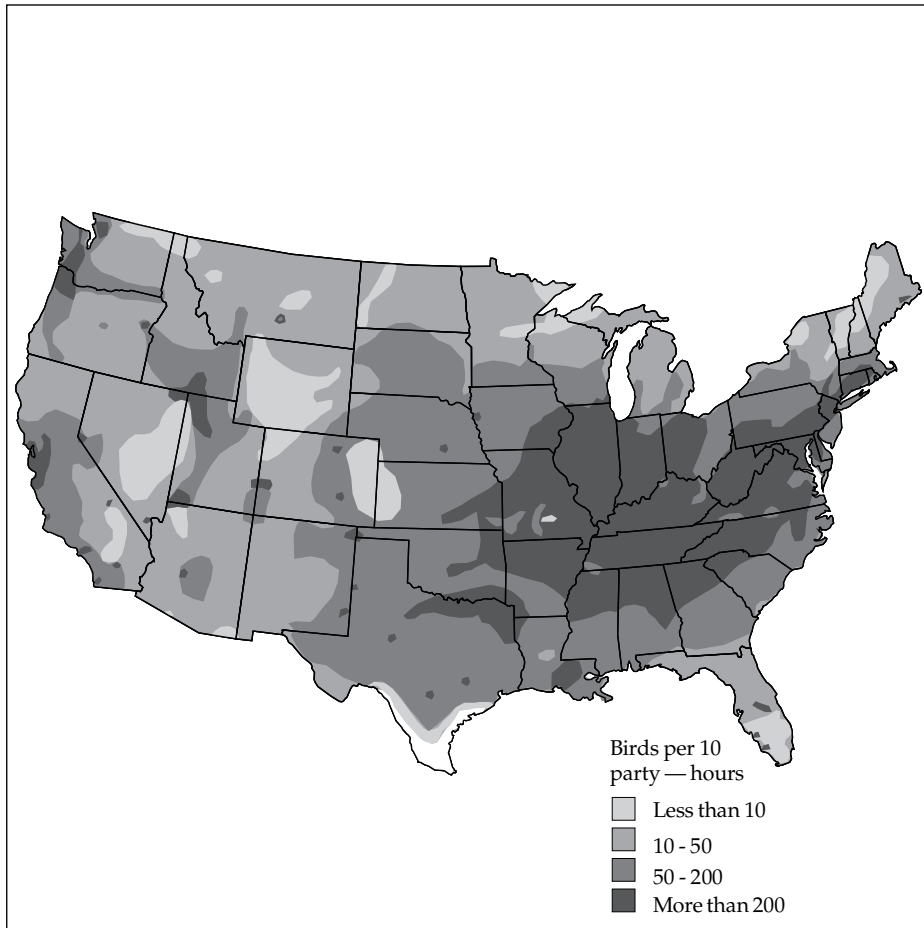

Fig. 2. Starling wintering areas, 1972. Map by J. W. Rosahn, based on the National Audubon Society's annual Christmas Bird Count.



Fig. 3. At livestock facilities such as this pig operation, European starlings consume feed, contaminate feed and water with their droppings, and may transmit disease.

some areas starlings pull sprouting grains, particularly winter wheat, and eat the planted seed. Starlings may damage turf on golf courses as they

probe for grubs, but the frequency and extent of such damage is not well documented.

The growing urbanization of wintering starling flocks seeking warmth and shelter for roosting may have serious consequences. Large roosts that occur in buildings, industrial structures, or, along with blackbird species, in trees near homes are a problem in both rural and urban sites because of health concerns, filth, noise, and odor. In addition, slippery accumulations of droppings pose safety hazards at industrial structures, and the acidity of droppings is corrosive.

Starling and blackbird roosts located near airports pose an aircraft safety hazard because of the potential for birds to be ingested into jet engines, resulting in aircraft damage or loss and, at times, in human injuries. In 1960, an Electra aircraft in Boston collided with a flock of starlings soon after takeoff, resulting in a crash landing and 62 fatalities. Although only about 6% of bird-aircraft strikes are associated with starlings or blackbirds, these species represent a substantial management challenge at airports.

One of the more serious health concerns is the fungal respiratory disease histoplasmosis. The fungus *Histoplasma capsulatum* may grow in the soils beneath bird roosts, and spores become airborne in dry weather, particularly when the site is disturbed. Although most cases of histoplasmosis are mild or even unnoticed, this disease can, in rare cases, cause blindness and/or death. Individuals who are weakened by other health conditions or who do not have endemic immunity are at greater risk from histoplasmosis.

Starlings also compete with native cavity-nesting birds such as bluebirds, flickers, and other woodpeckers, purple martins, and wood ducks for nest sites. One report showed that, where nest cavities were limited, starlings had severe impacts on local populations of native cavity-nesting species. One author has speculated that competition with starlings may cause shifts in red-bellied woodpecker (*Melanerpes carolinus*) nesting from urban habitats to rural forested areas where starling competition is less.

Legal Status

European starlings are not protected by federal law and in most cases not by state law. Laws vary among states, however, so check with state wildlife officials before beginning a control program. In addition, state or local laws may regulate or prohibit certain control techniques such as shooting or the use of toxicants.

Damage Prevention and Control Methods

Exclusion

Close all openings larger than 1 inch (2.5 cm) to exclude starlings from buildings or other structures. This is a permanent solution to problems inside the structure (Fig. 4). Heavy plastic (polyvinyl chloride, PVC) or rubber strips hung in open doorways of farm buildings have been successful in some areas in excluding birds while allowing people, machinery, or livestock to enter. Hang 10-inch (25-cm) wide strips with about 2.0-inch (5-cm) gaps between them. These strips might also be useful for protecting feed bunks. Netting over doorways may also exclude birds from buildings, but would be easily torn by machinery or livestock.

Where starlings are roosting or nesting on the ledge of a building, place a wooden, metal, or plexiglass covering over the ledge at a 45° angle to prevent use (Fig. 5). Metal protectors or porcupine wires (Nixalite® and Cat Claw®) are also available for preventing roosting on ledges or roof beams.

Nylon or plastic netting is another option for exclusion (Fig. 6). Exclude starlings that are roosting inside open farm buildings by covering the underside of the roof beams with netting. Netting is also useful for covering fruit crops such as cherries or grapes to prevent bird damage, and studies show it to be a cost-effective method of protecting higher-value grapes in commercial vineyards. For wine grapes harvested one time per season, tractor-mounted rollers can facilitate installation and removal of netting draped

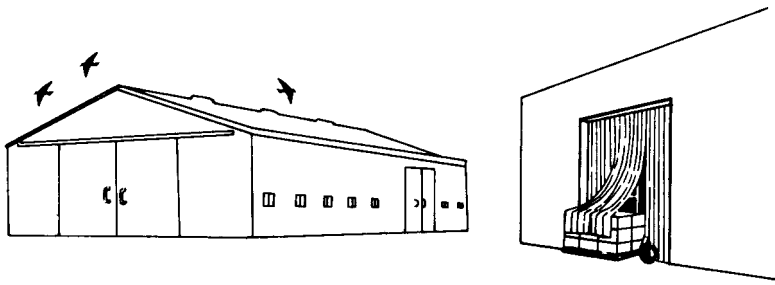

Fig. 4. Bird-proof buildings to permanently eliminate bird problems inside.

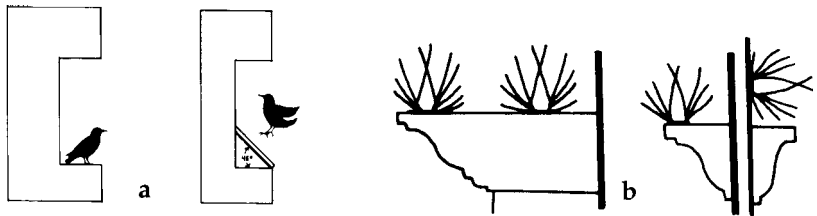

Fig. 5. A wooden, metal, or plexiglass covering over a ledge at a 45° angle (a) or porcupine wires (b) can be used to prevent roosting and nesting.

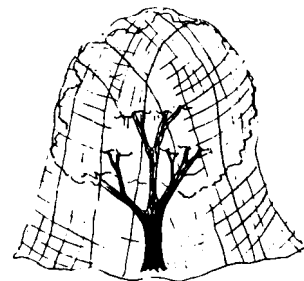
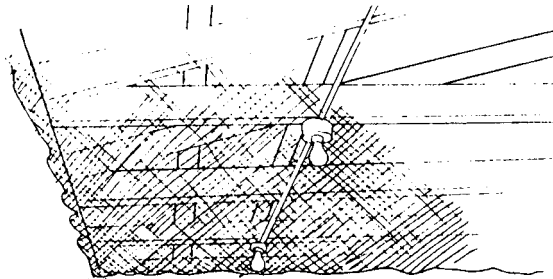

Fig. 6. Netting can be used to exclude birds from building rafters and from fruit trees.

directly over vines. Some New York vineyards have used this method for five years with the original netting still in good condition. For table grapes harvested by hand several times per year, a frame can be used to hold the netting above the vines so it doesn't interfere with the frequent harvests. A practical tip: if protecting the total vineyard is impractical, protect varieties that receive the most damage, those that ripen early or are otherwise highly attractive to birds (for example, small, dark, sweet grapes.)

Where starlings compete with other birds for nest boxes, proper nest box construction helps. For bluebird boxes, use a round 1 1/2-inch (3.8-cm) hole or a rectangular slot, 4 inches (10 cm) wide by 1 1/8 inches (29 mm) high, to allow bluebirds in but keep starlings out. Starlings are discouraged by horizontal wood duck nest boxes made from a 24-inch (61-cm) section of 12-inch-diameter (30.5-cm) stove pipe. The ends are made from wooden circles, and the entrance hole on one end is semicircular and 4 inches (10 cm) high by 11 inches (28 cm) wide. Other nest box features such as interior dimensions and color, amount of light allowed into the box, and box placement appear to have potential for discouraging starlings while encouraging preferred cavity-nesters.

Cultural Methods and Habitat Modification

Livestock Facilities. Starlings are attracted to livestock operations by the food and water that is available to them. Feedlots offer an especially attractive food source to starlings during winter when snow cover and frozen ground impede their normal feeding in open fields or other areas. The snow cover and frozen ground increase the likelihood as well as the severity of damage.

Some livestock operations are more attractive to starlings than others. Operations that have large quantities of feed always available, especially when located near a starling roost, are the most likely to have damage problems. Research results emphasize the importance of farm management prac-

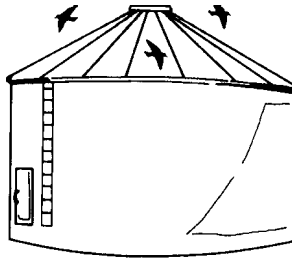

Fig. 7. Use bird-proof facilities to store grain.

tices in long-term starling control. These practices limit the availability of food and water to starlings, thus making the livestock environment less attractive to birds. The following practices used singly, but preferably in combination, will reduce feed losses, the chance of disease transmission, and the cost and labor of conventional control measures.

1. Clean up spilled grain.
2. Store grain in bird-proof facilities (Fig. 7).
3. Use bird-proof livestock feeders. These include flip-top pig feeders, lick wheels for liquid cattle supplement, and automatic-release feeders (magnetic or electronic) for costly high-protein rations. Using covered feeders prevents starling access and contamination of the food source, and the banging of the lift-top lids as pigs use the feeders may frighten starlings and keep them uneasy. Avoid feeding on the ground because this is an open invitation to starlings.

4. Where possible, feed livestock in covered areas such as open sheds because these areas are less attractive to starlings.
5. Use feed forms that starlings cannot swallow, such as cubes or blocks greater than 1/2 inch (1.3 cm) in diameter. Minimize use of 3/16 inch (0.5 cm) pellets; starlings consume these six times faster than granular meal.
6. When feeding protein supplements with other rations, such as silage, mix them well to limit starling access to the supplements.
7. Where possible, adjust feeding schedules so that exposure of feed to birds is minimized. For example, when feeding once per day, such as in a limited energy-feeding program for gestating sows, delay the feeding until late in the afternoon when foraging by starlings is decreased. Feed cattle at night if possible. Starlings prefer to feed early to midday and in areas where feed is constantly available. Feeding schedules that take these factors into account minimize problems.
8. Starlings are especially attracted to water. Drain or fill in unnecessary water pools around livestock operations. Where feasible, control the water level of livestock waterers to make them unavailable or less attractive to starlings (Fig. 8).

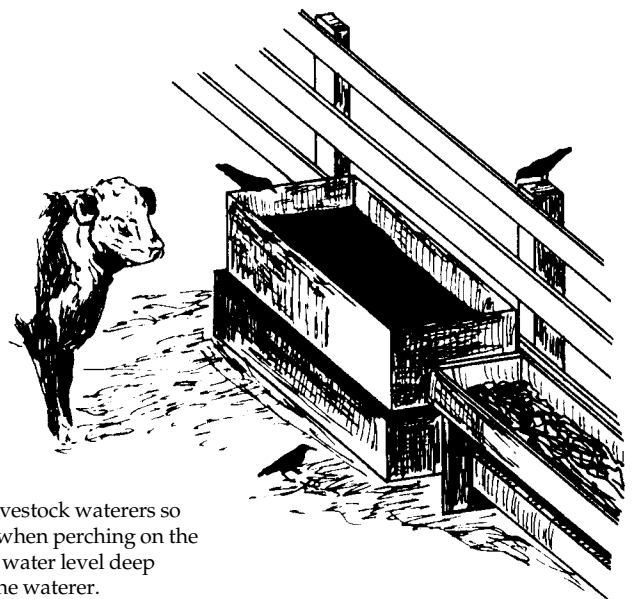

Fig. 8. Lower the water level in livestock waterers so starlings cannot reach the water when perching on the edge. At the same time, keep the water level deep enough so they cannot stand in the waterer.

Tree Roosts. When roosts occur in a small number of landscape trees near homes or along streets, thinning branches from the trees used by birds will usually disperse them. Roosts in tree groves or woodlots usually occur in dense, overcrowded stands of young trees. Remove about one-third of the trees to improve the tree stand, especially if marked by a professional forester, and to disperse the birds. Such thinning successfully dispersed roosts from research woodlots in Ohio and Kentucky, and from at least two problem-roost situations in Nebraska. In dense cedar thickets, bulldozing strips through the roost to remove one-third of the habitat has also been successful in dispersing birds. Soil disturbance, however, may be hazardous if soils harbor fungal spores of the human respiratory disease histoplasmosis. For further information on roost dispersal, see **Bird Dispersal Techniques**.

Frightening

Frightening is effective in dispersing starlings from roosts, small-scale fruit crops, and some other troublesome sites. It is useful around livestock operations that have warm climates year-round, and where major concentrations of wintering starlings exist. In the central states, starlings concentrate at livestock facilities primarily during cold winter months when snow covers natural food sources. At this time, baiting and other techniques are generally more effective than frightening. In addition, frightening starlings may disperse birds to other livestock facilities, a negative point that should be considered if disease transfer is a concern.

Frightening devices include recorded distress or alarm calls, gas-operated exploders, battery-operated alarms, pyrotechnics (shellcrackers, bird bombs), chemical frightening agents (see Avitrol® below), lights (for roosting sites at night), bright objects, and various other stimuli. Some novel visual frightening devices with potential effectiveness are eye-spot balloons, hawk kites, and mylar reflective tape. Ultrasonic (high frequency, above 20 kHz) sounds are not effective in fright-

ening starlings and most other birds because, like humans, they do not hear these sounds.

Harassing birds throughout the evening as they land can be effective in dispersing bird roosts if done for three to four consecutive evenings or until birds no longer return. Spraying birds with water from a hose or from sprinklers mounted in the roost trees has helped in some situations. Beating on tin sheets or barrels with clubs also scares birds. A combination of several scare techniques used together works better than a single technique used alone. Vary the location, intensity, and types of scare devices to increase their effectiveness. Two additional tips for successful frightening efforts: 1) begin early before birds form a strong attachment to the site, and 2) be persistent until the problem is solved. For a more detailed discussion of frightening techniques, see **Bird Dispersal Techniques**.

Avitrol®. Avitrol® (active ingredient: 4-aminopyridine) is a Restricted Use Pesticide available in several bait formulations for use as a chemical frightening agent. It is for sale only to certified applicators or persons under their direct supervision and only for those uses covered by the applicator's certification.

Avitrol® baits contain a small number of treated grains or pellets mixed with many untreated grains or pellets. Birds that eat the treated portion of the bait behave erratically and/or give warning cries that frighten other birds from the area. Generally, birds that eat the treated particles will die. Avitrol® baits are available for controlling starlings at feedlots and structures. At the dilution rates registered for use at feedlots, there is a low but potential hazard to nontarget hawks and owls that might eat birds killed by Avitrol®. It is therefore important to pick up and bury or incinerate any dead starlings found.

Around livestock operations, Avitrol® is sometimes used where the goal is to frighten or disperse the birds rather than to kill them. However, many birds may be killed, and data are lacking on whether the results of Avitrol®

use at feedlots occur because of frightening aspects or from direct mortality.

Three Avitrol® formulations are labeled for starling control at feedlots (Pelletized Feed, Double Strength Corn Chops, and Powder Mix). The formulation most appropriate for a given situation may vary, particularly if large numbers of blackbirds are mixed with the starlings. However, the Pelletized Feed formulation is generally recommended for starling control because starlings usually prefer pellets over cracked corn (corn chops). The Double Strength Corn Chops formulation is probably best for mixed flocks of starlings and blackbirds. Because Avitrol® is designed as a frightening agent, birds can develop bait shyness (bait rejection) fairly quickly. Prebaiting for several days with untreated pellets may be necessary for effective bait consumption and control. If starling problems persist, changing bait locations and additional prebaiting may be needed. If any Avitrol® baits are to be used, contact a qualified person trained in bird control work (someone from USDA-APHIS-ADC or Cooperative Extension, for example) for technical assistance.

Repellents

Soft, sticky repellents such as Roost-No-More®, Bird Tanglefoot®, 4-The-Birds®, and others consist of polybutenes, a nontoxic material that can be useful in discouraging starlings from roosting on sites such as ledges, roof beams, or shopping-center signs. It is often helpful to first put masking tape on the surface needing protection, then apply the repellent onto the tape; this increases effectiveness on porous surfaces and makes removal easier. Over time, these materials lose their effectiveness and have to be replaced.

Recent research has found that flavoring used in grape soft drinks, dimethyl anthranilate (DMA), and methyl anthranilate (MA) repel starlings from livestock feed at rates that do not affect cattle. Although subsequent field trials showed that DMA may not be cost-effective in some situations, results have indicated that MA has potential for cost-effective starling repellency.

Research is ongoing to improve the cost-effectiveness of this compound and to develop its potential for managing starlings at livestock facilities and possibly for repelling birds from fruit crops.

Toxicants

When using toxicants or other pesticides, always refer to the current pesticide label and follow its instructions as the final authority on pesticide use.

Starlicide. A chemical compound developed for starling control during the 1960s by the Denver Wildlife Research Center is now commercially available as a pelletized bait. It is sold under the trade name Starlicide Complete (0.1% 3-chloro *p*-toluidine hydrochloride).

Starlicide is a slow-acting toxicant for controlling starlings and blackbirds around livestock and poultry operations. It is toxic to other types of birds in differing amounts, but will not kill house (English) sparrows (*Passer domesticus*) at registered levels. Mammals are generally resistant to its toxic effects.

Poisoned birds experience a slow, non-violent death. They usually die from 1 to 3 days after feeding, often at their roost. Generally, few dead starlings will be found at the bait site. Poisoned starlings are not dangerous to scavengers or predators. However, to provide good sanitation and to prevent the spread of diseases that the birds may carry, pick up and bury or incinerate any dead starlings.

It is important to use fresh bait, as the current formulation of Starlicide Complete loses effectiveness in storage. Bait kept on hand from one winter to the next may lose some of its potency, and bait kept for 2 years may not work at all.

How to Use. Field tests in both the western and eastern United States have established guidelines for using Starlicide. For the best success in a control program, we recommend the following steps:

1. *Observe* birds feeding in and around the livestock operation. Note the

number of starlings and when and where they prefer to feed. The best time for observing is usually during the first few hours following sunrise when birds are seeking their morning meal.

2. *Determine* what species of birds are feeding. If any protected birds, such as doves, quail, pheasants, or songbirds, are present, do not apply toxic bait. For assistance or advice on bird identification or nontarget risk assessment based on the situation, contact your local Cooperative Extension office, USDA-APHIS-ADC office, or the state wildlife agency.
3. *Prebait*, for best results, with a non-poisonous bait to accustom starlings to feeding on bait at particular locations. Place the prebait in areas where the starlings concentrate to feed, but where it will not be accessible to livestock or other nontarget animals. The best prebait is a high-quality food that resembles the toxic bait in color, size, and texture. If such prebait is unavailable, use a good quality feed such as that normally fed to livestock.

Prebait for 1 to 4 days until the birds readily feed on the prebait. If good consumption is not obtained,

move the prebait to another location where starlings are concentrating to feed.

4. *Apply* prebait and bait on cold days when snow covers the ground. This timing is more effective because starlings become stressed for food and concentrate in livestock feeding areas.
5. *Place prebait and bait* in containers to ensure proper bait placement and to protect it from the weather (Fig. 9). Black rubber calf feeder pans work well. They do not tip easily, their dark color does not frighten birds, and bait is openly exposed. Empty farm wagons, feeder lids turned upside down, wooden troughs, or other containers may also work. Avoid brightly colored or shiny containers or ones that might tip and spill bait. At night, the containers can be covered to protect the bait from the weather. However, they must be uncovered at dawn so that starlings can feed as soon as they arrive. At feedlots where large numbers of starlings (more than 100,000) are involved, and where large quantities of feed are available on the ground, broadcasting bait in alleyways as per label directions is recommended.

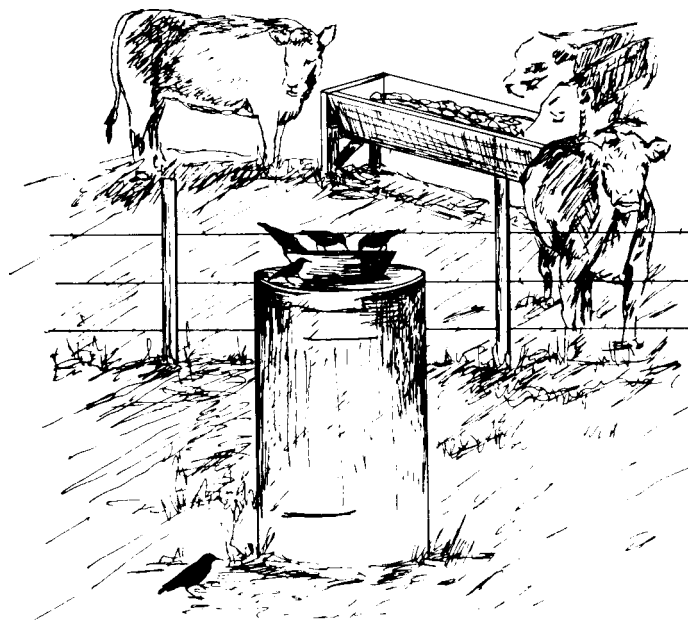

Fig. 9. Well-positioned bait containers, excluded from livestock, provide better safety and control in baiting programs for starlings.

6. *Apply toxic bait* after starlings feed readily on the prebait by removing all prebait and replacing it with the toxic bait. Consult the label directions for the amount to use (1 pound [0.45 kg] of Starlicide Complete used properly will kill about 100 to 200 starlings). The total number of starlings using a farm over a long period of time may greatly exceed the numbers observed on a given day, so continue baiting for at least 2 or 3 days or until bait consumption diminishes. Bait should be available to the starlings at all times when they are present.

Good bait acceptance may be more difficult to obtain in warm-weather climates such as in the southern-most states. If this occurs, and the Starlicide Complete bait is not eaten, an alternative may be to use Starlicide Technical (98% active ingredient) applied to baits such as french-fried potatoes, small fruits, or livestock feed according to label directions. The french fries and fruits may be more attractive to starlings, but they can spoil rapidly. Generally, livestock feed makes an acceptable bait because starlings are accustomed to feeding on it. Starlicide Technical can be used only by or under supervision of the USDA-APHIS-ADC for control of blackbirds and starlings at livestock operations. Contact them for help.

7. *Remove bait* after bait consumption diminishes. Observe any birds arriving at the feedlot during the next 2 to 3 mornings after baiting. Reduced bird numbers at this time indicate control, as most birds will die at the roost. If starlings continue to be present, or if they gradually return in increasing numbers, wait until a number of birds are regularly returning to feed at the area. Then apply prebait and toxic bait (Steps 4 to 6) as before. Do not leave Starlicide baits exposed for prolonged periods because this may cause bait shyness (bait rejection), and may also increase hazards to protected bird species.
8. *Group baiting* may increase effectiveness. Consider coordinating control

efforts with your neighbors. Several persons baiting at the same time will produce better control because starlings may forage over a large geographical area and may change feeding sites from day to day. Notify local wildlife officials of your plans so that if large numbers of starlings are removed, the officials will be able to explain the die-off. Contact USDA-APHIS-ADC officials about the possibility of using roost control procedures if a large roost is associated with the damage problem.

9. *Cautions:* Starlicide is poisonous to chickens, turkeys, ducks, and some other birds. Never expose bait where poultry, livestock, or nontarget wildlife can feed on it. Do not repackage pesticides into anything other than their original containers. Read and follow all label directions.

Toxic Perches. Toxic perches are perforated metal tubes 24 or 27 inches (61 or 69 cm) long containing a wick saturated with a contact toxicant that enters the feet as the birds perch on the tube. They can be safely and effectively used in certain industrial and other structural roost situations where they do not present hazards to nontarget birds and avian predators such as hawks and owls. All killed birds should be picked up immediately and buried or burned because of potential hazards to other wildlife.

The active ingredient in toxic perches, fenthion (Rid-A-Bird Perch 1100 Solution), is federally registered as a Restricted Use Pesticide for use in these perches. Fenthion is rapidly absorbed through the skin and should be used with caution to avoid spillage and exposure to the handler. It is toxic to humans, birds, fish, and aquatic invertebrates. For additional information on fenthion, refer to **Pesticides**.

Agents for Roost Control. Roost control has been used to reduce starling damage at livestock feedlots and in urban areas where there are human health and sanitation concerns. A recent study indicates, however, that roost control with wetting agents (no longer registered) may not consistently

provide long-term reduction of birds at feedlots, despite mostly favorable results in reducing urban problems. The presence of other roosting populations near the treated roost may be an important factor. At urban sites having mild winter climates, the accumulation of bird carcasses can produce a severe odor and fly problem if carcasses are not picked up or buried at the site soon after roost treatment. Bulldozing sites is the most efficient method to bury carcasses, but soil disturbance during this process may present human health hazards from dissemination of histoplasmosis spores. Such roost control should be considered only as a last resort when other alternatives are not likely to solve the problem in livestock and urban roost situations.

Currently, the only material registered for roost control is Starlicide Technical, which is used for baiting at or near roost sites in areas where starlings congregate before roosting. This method is currently registered for use in only a few states and only under supervision of USDA-APHIS-ADC personnel. A federal registration is pending. Although this method of roost control is labor-intensive, it has been effective.

Fumigants

Fumigation is generally not practical for starling control, and no fumigants are registered for this purpose.

Trapping

Trapping and removing starlings can be a successful method of control at locations where a resident population is causing localized damage or where other techniques cannot be used. An example is trapping starlings in a fruit orchard.

Two types of traps, nest-box and decoy traps, are commonly used. Nest-box traps (Fig. 10) are successful only during the nesting season, whereas decoy traps (Fig. 11) are most effective during other times when the birds are flocking. Nontarget birds captured in traps should be immediately released unharmed.

Decoy traps for starlings should be at least 5 to 6 feet (1.5 to 1.8 m) high to

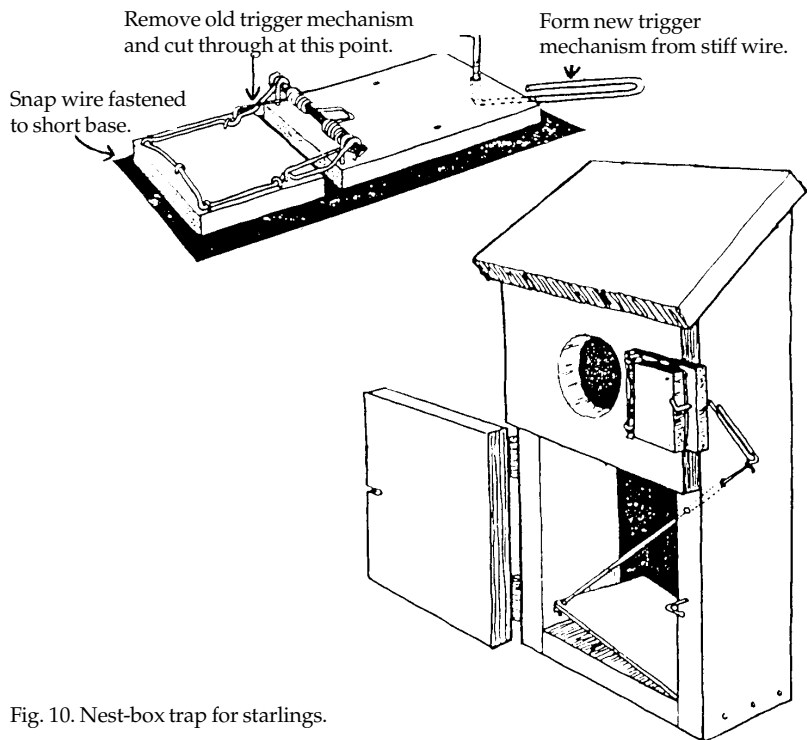

Fig. 10. Nest-box trap for starlings.

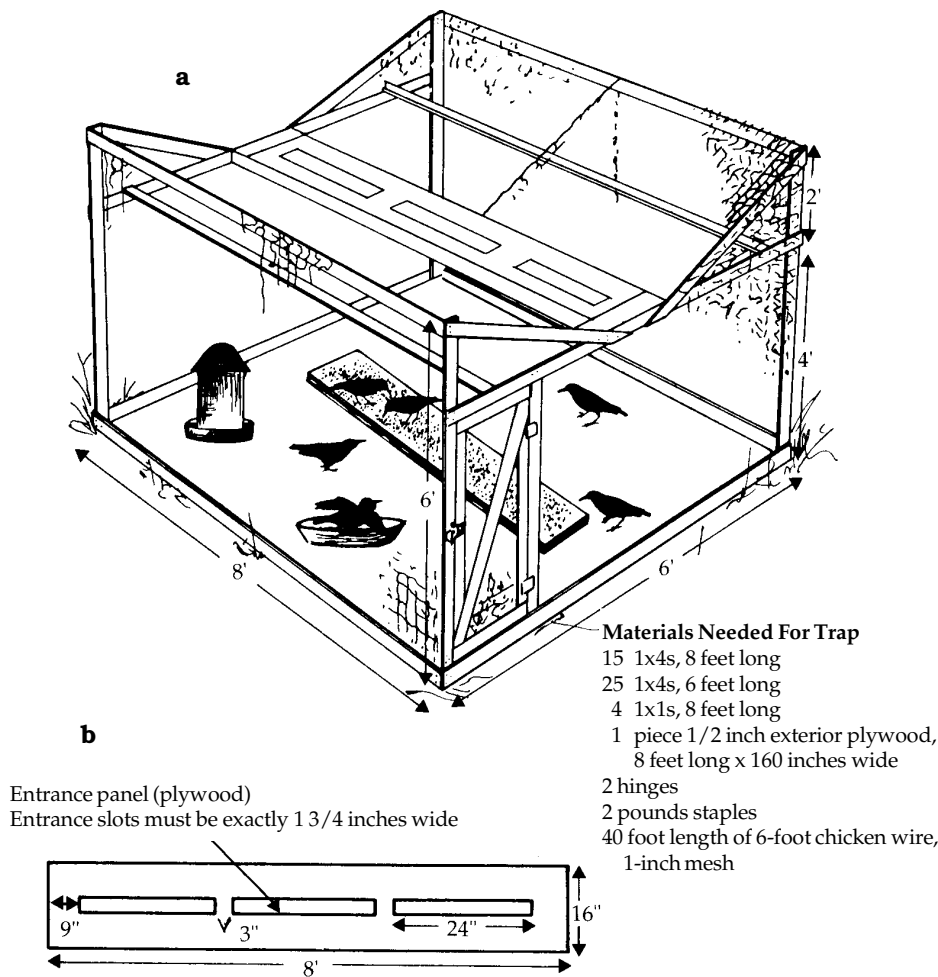

Fig. 11. Starling decoy trap: (a) assembled view and (b) details of the entrance panel. Side and end panels are covered with wire on the outside; top panels are covered on the inside of the frame.

allow for servicing and can be quite large (for example, 10 feet [3 m] wide by 30 feet [9 m] long). A convenient size is 6 x 8 x 6 feet (1.8 x 2.4 x 1.8 m) (Fig. 11). If desired, the sides and top can be constructed in panels to facilitate transportation and storage. In addition, decoy traps can be set up on a farm wagon and thereby moved to the best places to catch starlings. Place traps where starlings are likely to congregate. Leave a few starlings in the trap as decoys; their feeding behavior and calls attract other starlings that are nearby. Decoy birds in the trap must be well watered (which may include a bird bath) and fed. A well-maintained decoy trap can capture 100 or more starlings per day depending on its size and location, the time of year, and how well the trap is maintained. Euthanize captured starlings humanely such as by carbon dioxide exposure or cervical dislocation.

Shooting

Shooting is more effective as a dispersal technique than as a way to reduce starling numbers. The number of starlings that can be killed by shooting is very small in relation to the number of starlings usually involved in pest situations. Shooting, however, can be helpful to supplement and reinforce other dispersal techniques. For more detail on dispersal, see *Bird Dispersal Techniques*.

Economics of Damage and Control

Consumption of livestock feed by starlings can at times be a substantial economic consideration. Data reported in 1968 from Colorado feedlots estimated the cost of cattle rations consumed during winter by starlings at \$84 per 1,000 starlings. Current feed costs and the associated losses would certainly be much higher. A 1967 report indicated that 1 million starlings at a California feedlot resulted in losses of \$1,000 per day because of food consumption and contamination, and starling interference with cattle feeding activity. Another report estimated

that starlings in Idaho consumed 15 to 20 tons (13.5 to 18 mt) of cattle feed per day. A 1978 study in England estimated that the food eaten by starlings in a calf-rearing unit over three winters was 6% to 12% of the food presented to the calves. Two other studies in England since then found 4% losses and negligible damage, respectively.

Producers who wish to estimate feed losses to starlings at their facilities can do so using one of two methods. The following equation, which was developed from data in Colorado, estimates the cost of feed consumed per day:

$$\begin{aligned} \text{Cost of feed ration consumed per} \\ \text{day} = & \text{estimated starlings (to the} \\ & \text{nearest 1,000)} \times \text{fraction of birds} \\ & \text{using trough} \times \text{cost of feed ration} \\ & \text{per pound (0.4536 kg)} \times 0.0625 \\ & \text{pound (0.02813 kg) consumed} \\ & \text{per starling per day.} \end{aligned}$$

A second method, which may be applicable to most geographic areas, precludes the need of estimating starling populations. It requires the operator to observe the feed troughs several times during the day and estimate the number of starlings entering the troughs per day. From this estimate the cost of the feed ration consumed per day can be estimated with the following equation:

$$\begin{aligned} \text{Cost of feed ration consumed per} \\ \text{day} = & \text{estimated starling entries} \\ & \text{into troughs} \times 0.0033 \text{ pounds} \\ & \text{(0.0015 kg) consumed per star-} \\ & \text{ling entry} \times \text{cost of feed ration} \\ & \text{per pound (0.4536 kg).} \end{aligned}$$

These losses projected over a 3- to 4-month damage season can assist in evaluating the costs and benefits of proposed control measures.

Feed contamination from starling excreta may not be an economic loss for cattle or pig operations. In 2 years of testing at Western Kentucky University, neither pigs nor cattle were adversely affected by long-term exposure to feed heavily contaminated with starling excreta. As compared to controls, no significant differences were observed in weight gain or feed efficiency (ratio of weight gain to weight of feed offered). In addition, there

were no observed differences in feed rejection or disease incidence. These results indicate that there is no economic justification for starling control based solely on feed contamination. However, the effects of livestock water contamination from starling excreta have not been well studied.

Starling interference with livestock feeding patterns may have economic importance. A study in England reported that calves in pens protected from starlings showed higher growth rates and better feed conversion than those in unprotected pens. This protection led to an increased profit margin. The difference observed, however, might have been caused by starlings in the unprotected pens consuming the calf food, especially the high protein portion, rather than by actual interference with the calf feeding.

The costs associated with starlings in the spread of livestock disease may at times be substantial. For example, during the severe winter of 1978-1979, a TGE outbreak occurred in southeast Nebraska, with over 10,000 pigs lost in 1 month in Gage County alone. Starlings were implicated because the TGE outbreak was concurrent with large flocks of starlings feeding at the same facilities. More recent data show that starlings are capable of carrying this disease in their feces. The role of starlings in disease transfer, however, needs further study.

Bird damage to grapes in the United States was estimated to be at least \$4.4 million in 1972; starlings were one of the species causing the most damage. Starlings, as well as many other species of birds, also damage ripening cherry crops. A 1972 study in Michigan found 17.4% of a total crop lost to birds. A 1975 study in England estimated damage at 14% (lower branches) to 21% (tree canopy) of the crop; similar 1976 data showed less damage. Starling damage to winter wheat in a study of 218 fields in three regions in Kentucky and Tennessee averaged 3.8%, 0.5%, and 0.4% respectively, with the most serious losses (more than 14%) occurring where wheat was planted late and fields were

within 11 miles (16 km) of a large starling roost.

Human health and safety problems associated with urban starling roosts include concerns about the disease histoplasmosis and about aircraft-bird collisions. Although serious problems occur only infrequently, they can have grievous consequences where loss of human life and/or permanent disability may occur. Moreover, equipment repair and replacement costs associated with aircraft-bird collisions can be substantial. For example, the costs of aircraft-bird collisions in the United States are estimated to be at least \$20 million per year to commercial aircraft and \$10 million per year to Air Force aircraft. These consequences mandate a thorough understanding of urban roost situations and timely roost management where the potential for human health and safety problems exists.

On the beneficial side, starlings eat large quantities of insects and other invertebrates, especially during spring. Many of these invertebrates, such as lawn grubs, are considered to be pests. This benefit, however, is partially offset by the fact that starlings often take over nest cavities of native insect-eating birds. As trends move toward lower pesticide use and sustainable, low-input turf and agricultural systems, the role of starlings and other birds may become more important. Research is needed to further understand potential positive impacts of starlings and to learn how to maximize potential benefits while minimizing problems.

Although starlings are frequently associated with damage problems, some of which clearly cause substantial economic losses, the economics of damage in relation to the cost and effectiveness of controls are not well understood. Several factors contribute to this: (1) Starlings are difficult to monitor because they often move long distances daily from roost to feeding areas, and many migrate. (2) Effectiveness of controls, particularly in relation to the total population in an area, is difficult to document. For example,

does population reduction in a particular situation reduce the problem or merely allow an influx of starlings from other areas, and how does this vary seasonally or annually? In addition, does lethal control just substitute for natural mortality or is it additive? (3) The economics of interactions with other species are difficult to measure. For example, how much is a bluebird or flicker worth, and what net benefits occur when starling interference with native cavity-nesting birds is considered? (4) Other factors such as weather and variation among problem situations complicates accurate evaluation of damage and the overall or long-term effectiveness of controls. These points, as well as others mentioned in this chapter, are examples of factors that must be considered in assessing the total economic impact of starlings. Clearly, to minimize starling-human conflicts we need a better understanding of starlings and their interactions with various habitats and control measures.

Acknowledgments

The references listed under "For Additional Information" and many others were used in preparing this chapter. Gratitude is extended to the authors and the many researchers and observers who contributed to this body of knowledge. We also thank M. Beck, J. Besser, R. Fritschen, D. Mott, A. Stickley, and R. Timm for comments on the first edition of this chapter, J. Andelt provided typing and technical assistance. We gratefully acknowledge M. Beck, R. Case, D. Mott, and A. Stickley for critical reviews of this second edition, and L. Germer, J. Gosey, and D. Reese for reviews of specific portions.

Figure 1 from US Fish and Wildlife Service (1974), "Controlling Starlings," Bulletin AC 209, Purdue University, West Lafayette, Indiana, modified and adapted by Renee Lanik, University of Nebraska-Lincoln.

Figure 2 from Bystrak et al. (1974), used with permission. Figure copyrighted by the National Audubon Society, Inc. Adapted by David Thornhill. Map by J. W. Rosahn, based on the National Audubon Society's annual Christmas Bird Count. Map reprinted by permission from "Wintering Areas of Bird Species Potentially Hazardous to Aircraft." D. Bystrak et al. (1974), National Audubon Society, Inc.

Figure 3 photo by Ron J. Johnson.

Figures 4 and 7 by Renee Lanik based on drawings by Jon Eggers and a drawing from Salmon and Gorenz's chapter "Cliff Swallows" in this publication.

Figure 5 by Renee Lanik, University of Nebraska-Lincoln.

Figure 6 by Jill Sack Johnson.

Figures 8 and 9 by Renee Lanik, University of Nebraska-Lincoln.

Figure 10 from DeHaven and Guarino (1969), adapted by Jill Sack Johnson.

Figure 11 by Renee Lanik based on E. R. Kalmbach (1939), "The Crow in Its Relation to Agriculture," US Dep. Agric. Farmer's Bull. No. 1102, rev. ed., Washington, DC. 21 pp., and US Fish Wildl. Serv. (no date), "Trapping Starlings," Bull. AC 210, Purdue Univ., West Lafayette, Indiana.

For Additional Information

Aubin, T. 1989. The role of frequency modulation in the process of distress calls recognition by the starling (*Sturnus vulgaris*). *Behav.* 108:57-72.

Barnes, T. G. 1991. Eastern bluebirds, nesting structure design and placement. College of Agric. Ext. Publ. FOR-52, Univ. Kentucky, Lexington. 4 pp.

Besser, J. F., J. W. DeGrazio, and J. L. Guarino. 1968. Costs of wintering starlings and red-winged blackbirds at feedlots. *J. Wildl. Manage.* 32:179-180.

Besser, J. F., W. C. Royall, Jr., and J. W. DeGrazio. 1967. Baiting starlings with DRC-1339 at a cattle feedlot. *J. Wildl. Manage.* 31:45-51.

Blokpoel, H. 1976. Bird hazards to aircraft. Clarke, Irwin & Co. Ltd., 236 pp.

Boudreau, C. W. 1975. How to win the war with pest birds. Wildl. Tech., Hollister, California. 174 pp.

Bystrak, D., C. S. Robbins, S. R. Drennan, and R. Arbib, eds. 1974. Wintering areas of bird species potentially hazardous to aircraft. A special report jointly prepared by the Natl. Audubon Soc. and the US Fish Wildl. Serv. Natl. Audubon Soc., Inc., New York. 156 pp.

Constantin, B., and J. Glahn. 1989. Controlling roosting starlings in industrial facilities by baiting. *Proc. Eastern Wildl. Damage Control Conf.* 4:47-52.

Crane, F. T., C. P. Stone, R. W. DeHaven, and D. F. Mott. 1976. Bird damage to grapes in the United States with emphasis on California. US Fish Wildl. Serv., Special Sci. Rep. - Wildl. No. 197. Washington, DC. 18 pp.

DeCino, T. J., D. J. Cunningham, and E. W. Schafer, Jr. 1966. Toxicity of DRC-1339 to starlings. *J. Wildl. Manage.* 30:249-253.

DeHaven, R. W., and J. L. Guarino. 1969. A nest-box trap for starlings. *Bird-Banding* 40:49-50.

Dolbeer, R. A. 1984. Blackbirds and starlings: population ecology and habits related to airport environments. *Proc. Wildl. Hazards to Aircraft Conf. Training Workshop.* Charleston, South Carolina, US Dep. Trans. Rep. DOT/FAA/AAS/84-1:149-159.

Dolbeer, R. A. 1989. Current status and potential of lethal means of reducing bird damage in agriculture. Pages 474-483 in H. Ouellet, ed., *Acta XIX Congressus Int. Ornithol.*, Vol. I. Univ. Ottawa Press, Ottawa, Canada.

Dolbeer, R. A., A. R. Stickley, Jr., and P. P. Woronecki. 1978/1979. Starling, *Sturnus vulgaris*, damage to sprouting wheat in Tennessee and Kentucky, U.S.A. *Prot. Ecol.* 1:159-169.

Dolbeer, R. A., P. P. Woronecki, R. L. Bruggers. 1986. Reflecting tapes repel blackbirds from millet, sunflowers, and sweet corn. *Wildl. Soc. Bull.* 14:418-425.

Dolbeer, R. A., P. P. Woronecki, A. R. Stickley, Jr., and S. B. White. 1978. Agricultural impacts of a winter population of blackbirds and starlings. *The Wilson Bull.* 90:31.

Feare, C. J. 1980. The economics of starling damage. Pages 39-55 in E. N. Wright, I. R. Inglis, and C. J. Feare, eds. *Bird problems in agriculture*, British Crop Prot. Council, Croydon, UK. 210 pp.

Feare, C. J. 1984. The starling. Oxford Univ. Press, New York. 315 pp.

Feare, C. J. 1989. The changing fortunes of an agricultural bird pest: the European starling. *Agric. Zool. Rev.* 3:317-342.

Feare, C. J., and K. P. Swannack. 1978. Starling damage and its prevention at an open-fronted calf yard. *An. Prod.* 26:259-265.

Fuller-Perrine, L. D., and M. E. Tobin. 1993. A method for applying and removing bird-exclusion netting in commercial vineyards. *Wildl. Soc. Bull.* 21:47-51.

Glahn, J. F. 1982. Use of starlicide to reduce starling damage at livestock feeding operations. *Proc. Great Plains Wildl. Damage Control Workshop* 5:273-277.

Glahn, J. F., and D. L. Otis. 1986. Factors influencing blackbird and European starling damage at livestock feeding operations. *J. Wildl. Manage.* 50:15-19.

Glahn, J. F., and W. Stone. 1984. Effects of starling excrement in the food of cattle and pigs. *An. Prod.* 38:439-446.

Glahn, J. F., S. K. Timbrook, and D. J. Twedt. 1987. Temporal use patterns of wintering starlings at a southeastern livestock farm: implications for damage control. *Proc. Eastern Wildl. Damage Control Conf.* 3:194-203.

Glahn, J. F., D. J. Twedt, and D. L. Otis. 1983. Estimating feed loss from starling use of livestock feed troughs. *Wildl. Soc. Bull.* 11:366-372.

- Glahn, J. F., A. R. Stickle, Jr., J. F. Heisterberg, and D. F. Mott. 1991. Impact of roost control on local urban and agricultural blackbird problems. *Wildl. Soc. Bull.* 19:511-522.
- Good, H. B., and D. M. Johnson. 1978. Nonlethal blackbird roost control. *Pest Control* 46:14ff.
- Gough, P. M., and J. W. Beyer. 1982. Bird-vectored diseases. *Proc. Great Plains Wildl. Damage Control Workshop* 5:260-272.
- Heisterberg, J. F., A. R. Stickle, Jr., K. M. Garner, and P. D. Foster, Jr. 1987. Controlling blackbirds and starlings at winter roosts using PA-14. *Proc. Eastern Wildl. Damage Control Conf.* 3:177-183.
- Holler, N. R., and E. W. Schafer, Jr. 1982. Potential secondary hazards of avitrol baits to sharp-shinned hawks and American kestrels. *J. Wildl. Manage.* 46:457-462.
- Ingold, D. J. 1989. Nesting phenology and competition for nest sites among red-headed and red-bellied woodpeckers and European starlings. *Auk* 106:209-217.
- Johnson, R. J., P. K. Cole, and W. W. Stroup. 1985. Starling response to three auditory stimuli. *J. Wildl. Manage.* 49:620-625.
- Johnson, R. J., and J. F. Glahn. 1992. Starling management in agriculture. *Coop. Ext. Publ. NCR 451*, Univ. Nebraska, Lincoln. 7pp.
- Lefebvre, P. W., and J. L. Seubert. 1970. Surfactants as blackbird stressing agents. *Proc. Vertebr. Pest Conf.* 4:156-161.
- Lumsden, H. G. 1986. Choice of nest boxes by tree swallows, *Tachycineta bicolor*, house wrens, *Troglodytes aedon*, eastern bluebirds, *Sialia sialis*, and European starlings, *Sturnus vulgaris*. *Can. Field-Nat.* 100:343-349.
- Lustick, S. 1976. Wetting as a means of bird control. *Proc. Bird Control Sem.* 7:41-47.
- Maccarone, A. D. 1987. Effect of snow cover on starling activity and foraging patterns. *Wilson Bull.* 99:94-97.
- Mason, J. R., J. F. Glahn, R. A. Dolbeer, and R. F. Reidinger. 1985. Field evaluation of dimethyl anthranilate as a bird repellent livestock feed additive. *J. Wildl. Manage.* 49:636-642.
- Meanley, B., and W. C. Royall, Jr. 1976. Nationwide estimates of blackbirds and starlings. *Proc. Bird Control Sem.* 7:39-40.
- McGivrey, F. B., and F. M. Uhler. 1971. A starling-deterrent wood duck nest box. *J. Wildl. Manage.* 35:793-797.
- Palmer, T. K. 1976. Pest bird damage in cattle feedlots: the integrated systems approach. *Proc. Vertebr. Pest Conf.* 7:17-21.
- Royall, W. C., Jr., T. C. DeCino, and J. F. Besser. 1967. Reduction of a starling population at a turkey farm. *Poultry Sci.* 46:1494-1495.
- Schmidt, R. H., and R. J. Johnson. 1984. Bird dispersal recordings: an overview. *Am. Soc. Testing Mat. STP 817*, Philadelphia, Pennsylvania 4:43-65.
- Shirota, Y., M. Sanada, and S. Masaki. 1983. Eyespotted balloons as a device to scare gray starlings. *Appl. Ent. Zool.* 18:545-549.
- Stables, E. R., and N. D. New. 1968. Birds and aircraft: the problems. Pages 3-16 in R. K. Murton and E. N. Wright, eds. *Problems of birds as pests*. Acad. Press, London.
- Stewart, P. A. 1978. Foraging behavior and length of dispersal flights of communally roosting starlings. *Bird-Banding* 49:113-115.
- Stickle, A. R., Jr. 1979. Extended use of staricide in reducing bird damage in southeastern feedlots. *Proc. Bird Control Sem.* 8:79-81.
- Stickle, A. R., Jr., D. J. Twedt, J. F. Heisterberg, D. F. Mott, and J. F. Glahn. 1986. Surfactant spray system for controlling blackbirds and starlings in urban roosts. *Wildl. Soc. Bull.* 14:412-418.
- Stickle, A. R., Jr., and R. J. Weeks. 1985. Histoplasmosis and its impact on blackbird-starling roost management. *Proc. Eastern Wildl. Damage Control Conf.* 2:163-171.
- Twedt, D. J., and J. F. Glahn. 1982. Reducing starling depredations at livestock feed operations through changes in management practices. *Proc. Vertebr. Pest Conf.* 10:159-163.
- Weitzel, N. H. 1988. Nest-site competition between the European starling and native breeding birds in northwestern Nevada. *Condor* 90:515-517.
- West, R. R. 1968. Reduction of a winter starling population by baiting its prerooting areas. *J. Wildl. Manage.* 32:637-640.
- West, R. R., J. F. Besser, and J. W. DeGrazio. 1967. Starling control in livestock feeding areas. *Proc. Vertebr. Pest Conf.*, 3:89-93.
- Will, T. J. 1983. BASH Team new developments. *Proc. Bird Control Sem.* 9:7-10.
- Wright, E. N. 1973. Experiments to control starling damage at intensive animal husbandry units. *European Plant Prot. Organiz. Bull.* 9:85-89.
- Wright, E. N. 1982. Bird problems and their solutions in Britain. *Proc. Vertebr. Pest Conf.* 10:186-189.

Editors

Scott E. Hygnstrom
Robert M. Timm
Gary E. Larson